



*"Experts in Specialist  
Wheels & Tyres"*

## PRODUCT INFORMATION

# Stainless steel thread and base with rubber pad

**Material:** Stainless steel thread and base cover (AISI 304/A2), vulcanised rubber base  
72° Shore A hardness. One bolt fixing series.

<b>Part number:</b>	HX106-20-150
<b>Thread size:</b>	M20
<b>Total height:</b>	178mm
<b>Thread length:</b>	139mm
<b>Base height:</b>	39mm
<b>Base diameter:</b>	105mm
<b>Max recommended load:</b>	2200kg
<b>Anti-slip:</b>	Yes

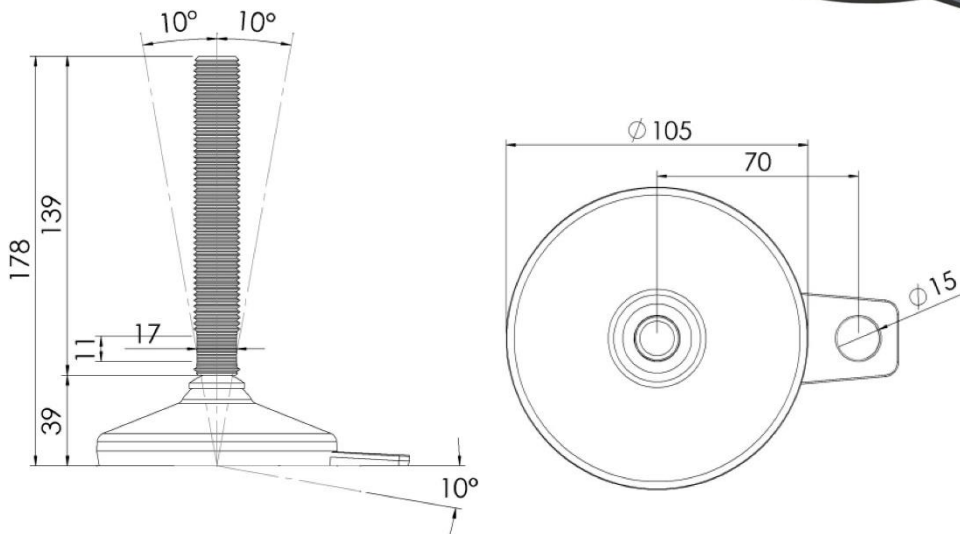

Telephone: (353) 1 452 0482  
Email: [info@parnell.eu](mailto:info@parnell.eu)

[www.parnells.eu](http://www.parnells.eu)

Unit A1 - A4  
Southcity Business Centre  
Whitestown Way  
Tallaght  
Dublin D24 HT95  
Ireland