



*"Experts in Specialist
Wheels & Tyres"*

PRODUCT INFORMATION

Rigid Levelling Foot

Material: Zinc plated thread on polypropylene base.

Part number:	5239
Thread size:	M8x1.25
Total height:	53mm
Thread length:	37mm
Base height:	16mm
Base diameter:	38mm
Max recommended load:	100kg

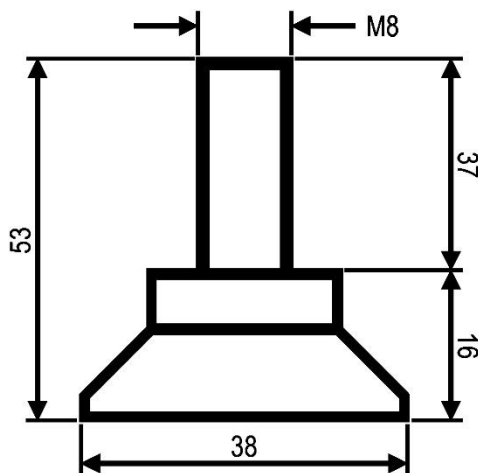

Telephone: (353) 1 452 0482
Email: info@parnell.eu

www.parnells.eu

Unit A1 - A4
Southcity Business Centre
Whitestown Way
Tallaght
Dublin D24 HT95
Ireland