



*"Experts in Specialist  
Wheels & Tyres"*

## PRODUCT INFORMATION

# Tilting Levelling Foot

**Material:** Zinc plated thread on polyethylene base.

<b>Part number:</b>	5014-40
<b>Thread size (D):</b>	M10x1.5
<b>Total height (H):</b>	57mm
<b>Thread length (L):</b>	37mm
<b>Base height (B):</b>	20mm
<b>Base diameter (A):</b>	40mm
<b>Max recommended load:</b>	100kg

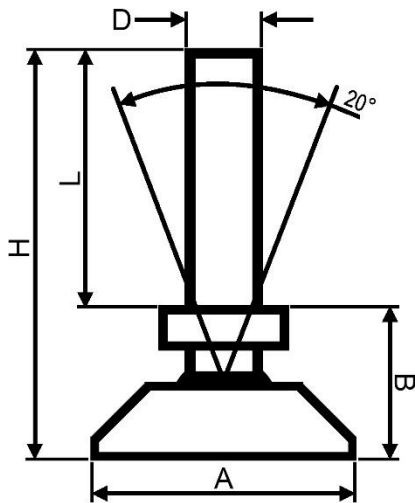

Telephone: (353) 1 452 0482  
Email: [info@parnell.eu](mailto:info@parnell.eu)

[www.parnells.eu](http://www.parnells.eu)

Unit A1 - A4  
Southcity Business Centre  
Whitestown Way  
Tallaght  
Dublin D24 HT95  
Ireland