



*"Experts in Specialist
Wheels & Tyres"*

PRODUCT INFORMATION

Tilting Levelling Foot

Material: Zinc plated thread on glass reinforced nylon base.

Part number:	R100-10-125
Thread size (D):	M10x1.5
Total height (H):	154mm
Thread length (L):	125mm
Base height (B):	29mm
Base diameter (A):	100mm
Max recommended load:	470kg

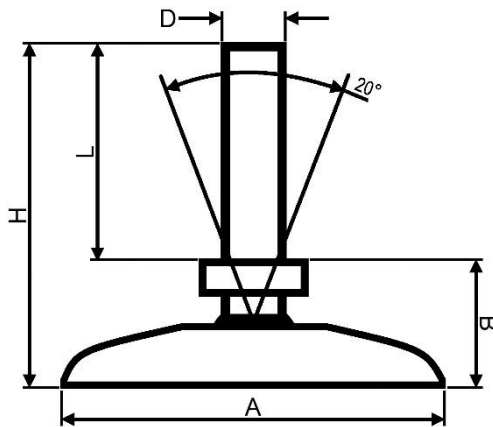

Telephone: (353) 1 452 0482
Email: info@parnell.eu

www.parnells.eu

Unit A1 - A4
Southcity Business Centre
Whitestown Way
Tallaght
Dublin D24 HT95
Ireland