



*"Experts in Specialist
Wheels & Tyres"*

PRODUCT INFORMATION

Tilting Levelling Foot With Holes

Material: Zinc plated thread on glass reinforced nylon base.

Part number:	R101-16-100
Thread size (D):	M16x2.0
Thread length (L):	100mm
Total height (H):	129mm
Base diameter (A):	100mm
Base height (B):	29mm
Hole position (C):	74mm
Hole diameter (E):	9mm
Max recommended load:	900kg

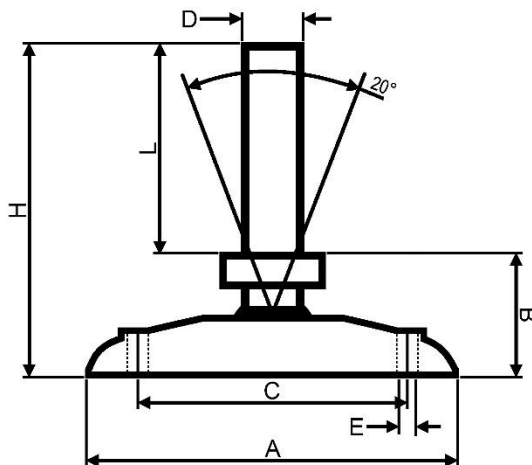

Telephone: (353) 1 452 0482
Email: info@parnell.s.eu

www.parnells.eu

Unit A1 - A4
Southcity Business Centre
Whitestown Way
Tallaght
Dublin D24 HT95
Ireland