



*"Experts in Specialist  
Wheels & Tyres"*

## PRODUCT INFORMATION

# Tilting Levelling Foot With Holes

**Material:** Zinc plated thread on glass reinforced nylon base.

<b>Part number:</b>	R101-16-150
<b>Thread size (D):</b>	M16x2.0
<b>Thread length (L):</b>	150mm
<b>Total height (H):</b>	179mm
<b>Base diameter (A):</b>	100mm
<b>Base height (B):</b>	29mm
<b>Hole position (C):</b>	74mm
<b>Hole diameter (E):</b>	9mm
<b>Max recommended load:</b>	900kg

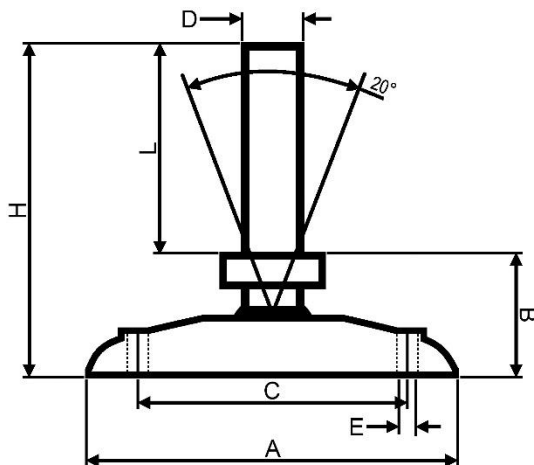

Telephone: (353) 1 452 0482  
Email: [info@parnell.s.eu](mailto:info@parnell.s.eu)

[www.parnells.eu](http://www.parnells.eu)

Unit A1 - A4  
Southcity Business Centre  
Whitestown Way  
Tallaght  
Dublin D24 HT95  
Ireland