



*"Experts in Specialist
Wheels & Tyres"*

PRODUCT INFORMATION

100 Series Bolt Hole Castor

Material: Zinc plated swivel bracket with bolt hole fitting. Wheels with grey thermoplastic rubber tread on polypropylene centre.

Part number:	762309
Wheel diameter (D):	50mm
Tread width (T2):	18mm
Tread hardness:	85° Shore A
Wheel bearing:	Plain bearing
Top plate diameter (C):	42mm
Bolt hole (d):	10,5mm
Offset (F):	32mm
Overall height (H):	71mm
Load capacity 3km/h:	70kg
Rolling resistance:	Very good
Operating noise:	Good
Floor preservation:	Good

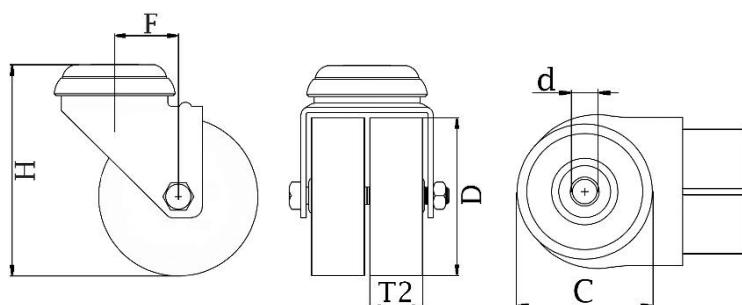

Telephone: (353) 1 452 0482
Email: info@parnell.eu

www.parnells.eu

Unit A1 - A2
Southcity Business Centre
Whitestown Way
Tallaght
Dublin D24 HT95
Ireland