



*"Experts in Specialist
Wheels & Tyres"*

PRODUCT INFORMATION

800 Series Top Plate Castor

Material: Zinc plated swivel bracket with top plate fitting. Wheel with black solid elastic rubber tyre on welded steel centre.

Part number:	230002
Wheel diameter (D):	160mm
Tread width (T2):	50mm
Tread hardness:	65° Shore A
Wheel bearing:	Ball bearings
Top plate size (AxB):	135x110mm
Fixing hole spacing (axb):	105x75-80mm
Fixing hole size (d):	11mm
Offset (F):	53mm
Overall height (H):	215mm
Load capacity 3km/h:	450kg
Rolling resistance:	Very good
Operating noise:	Very good
Floor preservation:	Very good

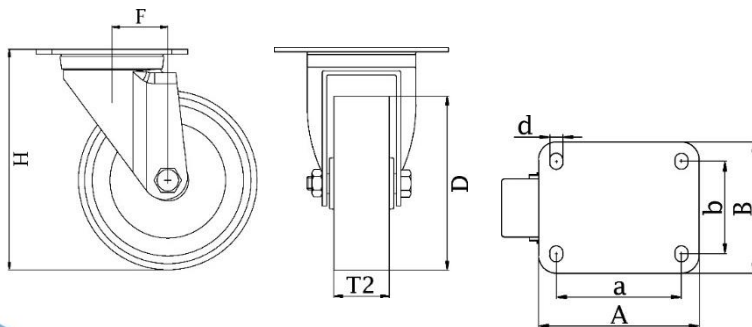

Telephone: (353) 1 452 0482
Email: info@parnell.eu

www.parnells.eu

Unit A1 - A2
Southcity Business Centre
Whitestown Way
Tallaght
Dublin D24 HT95
Ireland