



*"Experts in Specialist
Wheels & Tyres"*

PRODUCT INFORMATION

500 Series Top Plate Castor

Material: Zinc plated swivel bracket with top plate fitting. Wheel with red thermoplastic polyurethane tread on nylon centre.

Part number:	410003
Wheel diameter (D):	200mm
Tread width (T2):	50mm
Tread hardness:	98° Shore A
Wheel bearing:	Ball bearings
Top plate size (AxB):	140x110mm
Fixing hole spacing (axb):	105x80mm
Fixing hole size (d):	11mm
Offset (F):	40mm
Overall height (H):	236mm
Load capacity 3km/h:	500kg
Rolling resistance:	Very good
Operating noise:	Good
Floor preservation:	Good

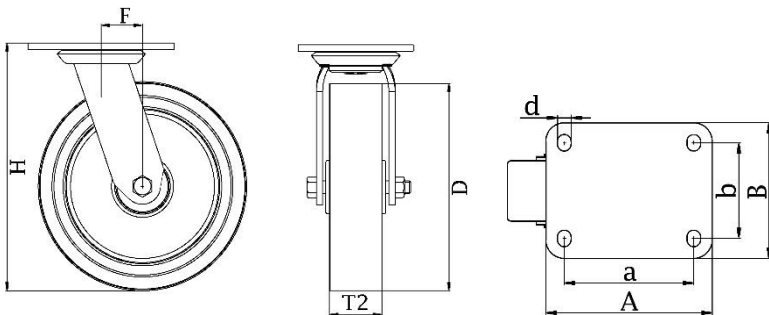

Telephone: (353) 1 452 0482
Email: info@parnell.eu

www.parnells.eu

Unit A1 - A2
Southcity Business Centre
Whitestown Way
Tallaght
Dublin D24 HT95
Ireland