



*"Experts in Specialist
Wheels & Tyres"*

PRODUCT INFORMATION

Polyurethane Wheel

Material: Brown polyurethane tread on cast iron centre, with keyway.

Part number:	459842
Wheel diameter (D):	200mm
Tread width (T2):	50mm
Tread hardness:	92° Shore A
Wheel bearing:	Plain bearing
Wheel bore (d):	25mm H7
Hub groove length (B):	8mm JS9
Hub groove height (H):	28,3mm
Hub length (T1):	60mm
Load capacity 3km/h:	900kg
Rolling resistance:	Very good
Operating noise:	Good
Floor preservation:	Good

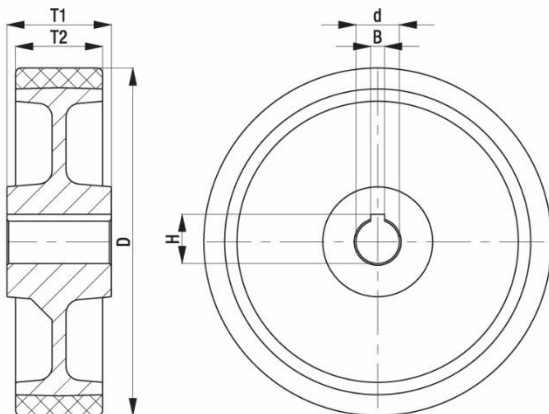

Telephone: (353) 1 452 0482
Email: info@parnell.eu

www.parnells.eu

Unit A1 - A2
Southcity Business Centre
Whitestown Way
Tallaght
Dublin D24 HT95
Ireland