



*"Experts in Specialist  
Wheels & Tyres"*

## PRODUCT INFORMATION

# Polyurethane Wheel

**Material:** Brown polyurethane tread on cast iron centre, with keyway.

<b>Part number:</b>	754421
<b>Wheel diameter (D):</b>	300mm
<b>Tread width (T2):</b>	60mm
<b>Tread hardness:</b>	92° Shore A
<b>Wheel bearing:</b>	Plain bearing
<b>Wheel bore (d):</b>	40mm H7
<b>Hub groove length (B):</b>	12mm JS9
<b>Hub groove height (H):</b>	43,3mm
<b>Hub length (T1):</b>	60mm
<b>Load capacity 3km/h:</b>	1500kg
<b>Rolling resistance:</b>	Very good
<b>Operating noise:</b>	Good
<b>Floor preservation:</b>	Good

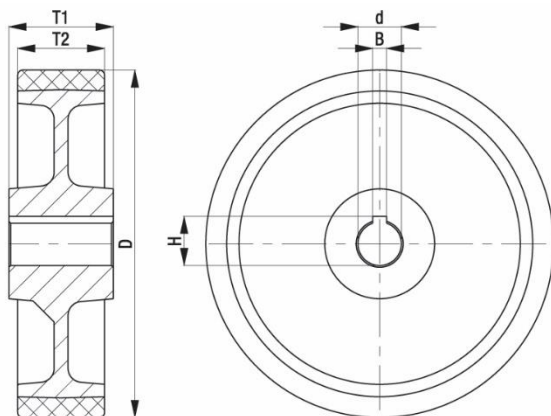

Telephone: (353) 1 452 0482  
Email: [info@parnell.eu](mailto:info@parnell.eu)

[www.parnells.eu](http://www.parnells.eu)

Unit A1 - A2  
Southcity Business Centre  
Whitestown Way  
Tallaght  
Dublin D24 HT95  
Ireland