



*"Experts in Specialist
Wheels & Tyres"*

PRODUCT INFORMATION

1500 Series Top Plate Castor

Material: Zinc plated swivel bracket with top plate fitting. White nylon wheel.

Part number:	140027
Wheel diameter (D):	250mm
Tread width (T2):	50mm
Tread hardness:	70° Shore D
Wheel bearing:	Ball bearings
Top plate size (AxB):	135x110mm
Fixing hole spacing (axb):	105x75-80mm
Fixing hole size (d):	11mm
Offset (F):	80mm
Overall height (H):	305mm
Load capacity 3km/h:	1500kg
Rolling resistance:	Excellent
Operating noise:	Reasonable
Floor preservation:	Reasonable

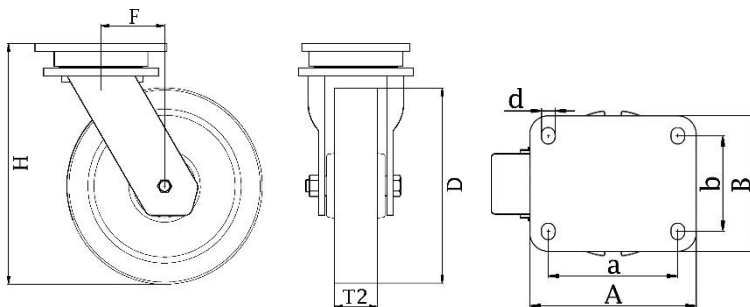

Telephone: (353) 1 452 0482
Email: info@parnell.eu

www.parnells.eu

Unit A1 - A2
Southcity Business Centre
Whitestown Way
Tallaght
Dublin D24 HT95
Ireland