



*"Experts in Specialist  
Wheels & Tyres"*

## PRODUCT INFORMATION

# 1500 Series Top Plate Castor

**Material:** Zinc plated swivel bracket with top plate fitting. Grey cast iron wheel.

<b>Part number:</b>	610009
<b>Wheel diameter (D):</b>	200mm
<b>Tread width (T2):</b>	45mm
<b>Wheel bearing:</b>	Roller bearing
<b>Top plate size (AxB):</b>	135x110mm
<b>Fixing hole spacing (axb):</b>	105x75-80mm
<b>Fixing hole size (d):</b>	11mm
<b>Offset (F):</b>	65mm
<b>Overall height (H):</b>	245mm
<b>Load capacity 3km/h:</b>	1150kg
<b>Rolling resistance:</b>	Excellent
<b>Operating noise:</b>	Sufficient
<b>Floor preservation:</b>	Sufficient

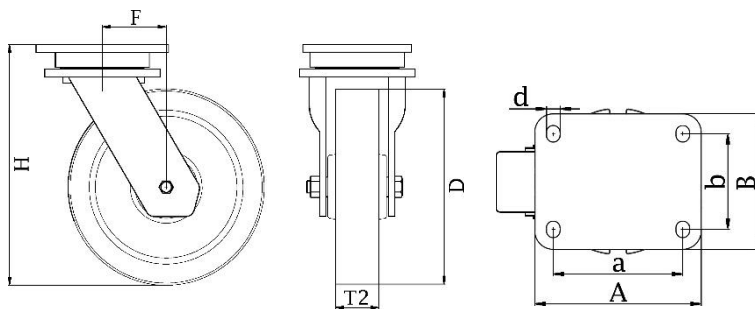

Telephone: (353) 1 452 0482  
Email: [info@parnell.eu](mailto:info@parnell.eu)

[www.parnells.eu](http://www.parnells.eu)

Unit A1 - A2  
Southcity Business Centre  
Whitestown Way  
Tallaght  
Dublin D24 HT95  
Ireland