

PRODUCT INFORMATION

Connectors for Overhead Track

Material: Zinc plated steel

Part number:	Connect1
A(mm)	41
B(mm)	48
Used with	Track1

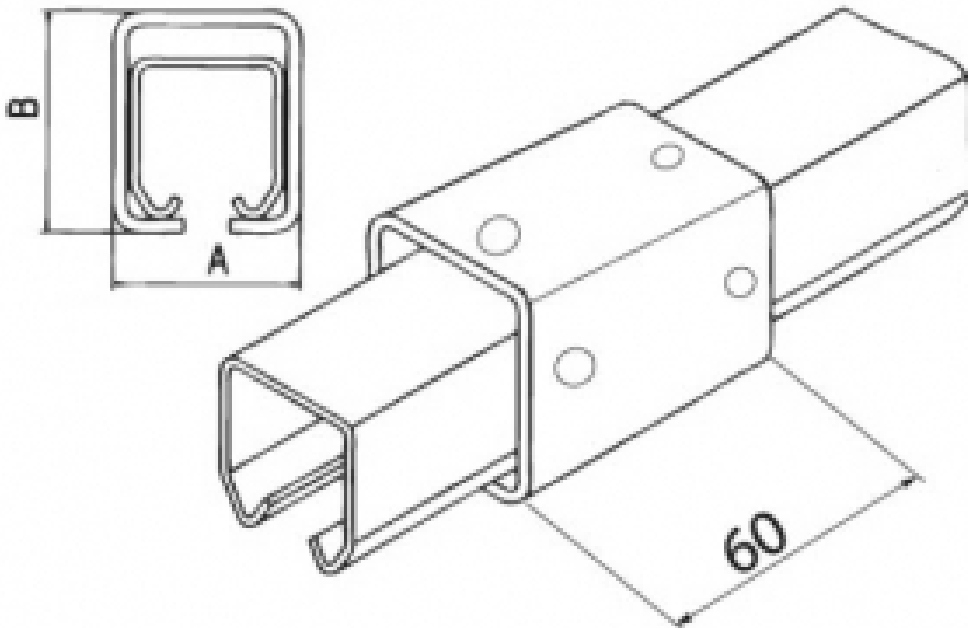

Telephone: (353) 1 452 0482
Email: info@parnell.eu

www.parnells.eu

Unit A1 - A4
Southcity Business Centre
Whitestown Way
Tallaght
Dublin D24 HT95
Ireland