



"Experts in Specialist
Wheels & Tyres"

PRODUCT INFORMATION

V Groove Wheel with 2 Ball Bearing

Material: Zinc plated steel

Supplied with Bolt, Nut and T-Bushes

Part number:	80-V-2BB
Ø(mm)	78
A(mm)	23
B(mm)	12x60
C(mm)	36
E(mm)	15
Bearing Number	6002 RS
Max Load(Kg)	250kg

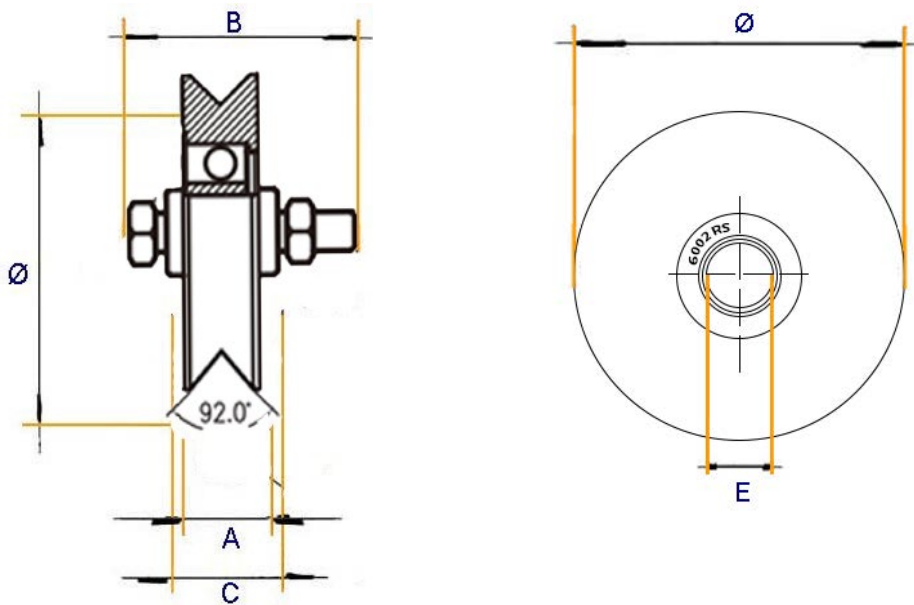

Telephone: (353) 1 452 0482
Email: info@parnell.eu

www.parnells.eu

Unit A1 - A4
Southcity Business Centre
Whitestown Way
Tallaght
Dublin D24 HT95
Ireland