



*"Experts in Specialist
Wheels & Tyres"*

PRODUCT INFORMATION

V Groove Wheel in Fixed Bracket

Material: Zinc plated steel

Part number:	50-V-FX
Ø(mm)	50
A(mm)	15
C(mm)	25
H(mm)	57
K(mm)	48
Max Load(Kg)	60kg

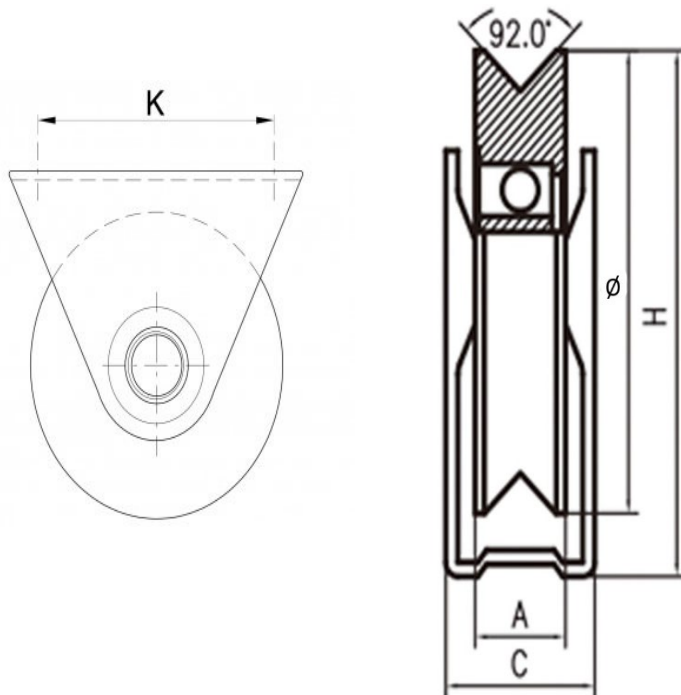

Telephone: (353) 1 452 0482
Email: info@parnell.eu

www.parnells.eu

Unit A1 - A4
Southcity Business Centre
Whitestown Way
Tallaght
Dublin D24 HT95
Ireland