



*"Experts in Specialist
Wheels & Tyres"*

PRODUCT INFORMATION

V Groove Wheel in Fixed Bracket

Material: Zinc plated steel

Part number:	60-V-FX
Ø(mm)	58
A(mm)	17
C(mm)	26.5
H(mm)	63
K(mm)	55
Max Load(Kg)	75kg

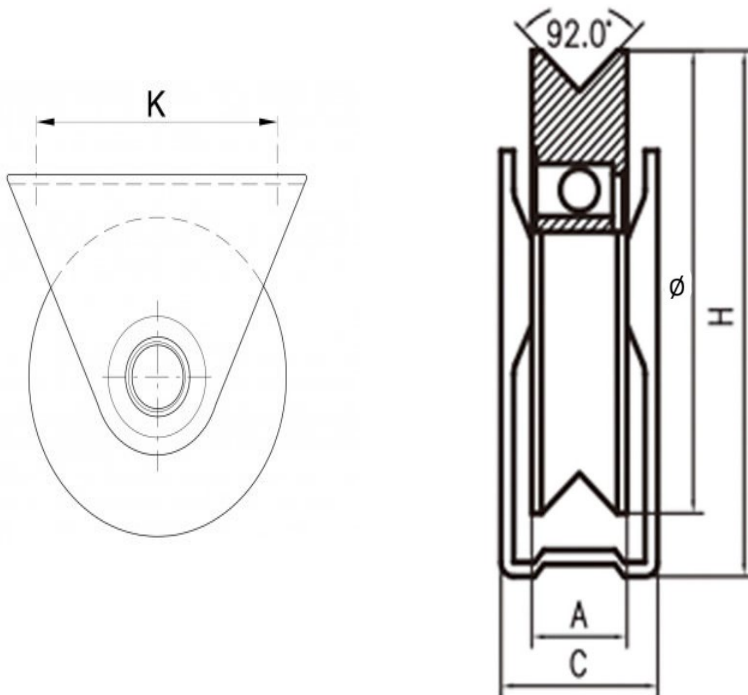

Telephone: (353) 1 452 0482
Email: info@parnell.eu

www.parnells.eu

Unit A1 - A4
Southcity Business Centre
Whitestown Way
Tallaght
Dublin D24 HT95
Ireland